

Characteristics of pressure wave in common rail fuel injection system of high-speed direct injection diesel engines

Mohammad Reza Herfatmanesh¹, Zhijun Peng¹, Alexis Ihracska¹,
Yuzhen Lin², Lipeng Lu² and Chi Zhang²

Abstract

The latest generation of high-pressure common rail equipment now provides diesel engines possibility to apply as many as eight separate injection pulses within the engine cycle for reducing emissions and for smoothing combustion. With these complicated injection arrangements, optimizations of operating parameters for various driving conditions are considerably difficult, particularly when integrating fuel injection parameters with other operating parameters such as exhaust gas recirculation rate and boost pressure together for evaluating calibration results. Understanding the detailed effects of fuel injection parameters upon combustion characteristics and emission formation is therefore particularly critical. In this article, the results and discussion of experimental investigations on a high-speed direct injection light-duty diesel engine test bed are presented for evaluating and analyzing the effects of main adjustable parameters of the fuel injection system on all regulated emission gases and torque performance. Main injection timing, rail pressure, pilot amount, and particularly pilot timing have been examined. The results show that optimization of each of those adjustable parameters is beneficial for emission reduction and torque improvement under different operating conditions. By exploring the variation in the interval between the pilot injection and the main injection, it is found that the pressure wave in the common rail has a significant influence on the subsequent injection. This suggests that special attentions must be paid for adjusting pilot timing or any injection interval when multi-injection is used. With analyzing the fuel amount oscillation of the subsequent injections to pilot separation, it demonstrates that the frequency of regular oscillations of the actual fuel amount or the injection pulse width with the variation in pilot separation is always the same for a specified fuel injection system, regardless of engine speed, fuel amount, injection pulse, and injection pressure.

Keywords

Diesel engine, common rail fuel injection, high pressure, pressure wave, multiple injections

Date received: 27 January 2016; accepted: 8 April 2016

Academic Editor: Jose Ramon Serrano

Introduction

With the contributions of high-pressure common rail (HPCR) injection system, variable geometry turbocharger (VGT), exhaust gas recirculation (EGR), and diesel particulate filter (DPF) for improving drivability and emissions, high-speed direct injection (HSDI) diesel engines have shared about 50% in European passenger

¹School of Engineering and Technology, University of Hertfordshire, Hatfield, UK

²School of Energy and Power Engineering, Beihang University, Beijing, China

Corresponding author:

Zhijun Peng, School of Engineering and Technology, University of Hertfordshire, Hatfield AL10 9AB, UK.

Email: z.peng2@herts.ac.uk



car market in recent years. In the mean time, technology innovation is continuously necessary, particularly to meet the next-generation emission regulations which are forecasted to reduce the expansion speed of the diesel territory. Diesel hybrid and homogeneous charge compression ignition (HCCI) combustion are the two examples of those technologies being developed. For HPCR fuel injection, after piezo-injector and 2500 bar injection pressure, 3000 bar injection pressure is being developed by those main suppliers and will come to market in the next several years for meeting the next-stage emission regulations.^{1,2}

Common rail fuel injection allows to adjust injection pressure, fuel injection amount, and injection timing very flexibly. It can also use multiple injections for optimizing combustion and emissions.³⁻⁵ Currently, it is possible to have up to eight injection pulses—two pilot, four main, and two post-injection pulses. Noise can be controlled by pilot injection, and the particulate/soot and gaseous emissions can be minimized by post-injection after the main injection. The efficiency of the catalytic converter is increased as unburned hydrocarbon (HC) is destroyed by the hot exhaust.

However, when using multiple injections with a very short interval between injection pulses, the effect of pressure wave in fuel pipe on the subsequent fuel injections must be paid attention. Due to the fast opening and closing of injector needle, the injection pressure waves are generated in the duct of common rail, injectors, and connecting high-pressure pipe and the injection pressure will no longer remain constant during the whole injection event.⁶⁻⁸ These pressure waves then push up or down the subsequent injection amount significantly and this makes the calibration of the subsequent injection fuel amount very difficult. Under different operating conditions, these influences may become much more serious.⁹ Therefore, it is essential to have a full understanding of this phenomenon.

In the study presented in this article, the operating characteristics of the common rail fuel injection system of high-speed light-duty diesel engine have been explored on a 2.2-L four-cylinder four-valve turbocharged passenger car direct injection (DI) diesel engine. The effects of main injection timing, injection pressure, pilot amount, and particularly pilot timing on emissions and torque performance have been experimental investigated. The pressure waves in the common rail and its influences on the subsequent injection were examined with two different test methods (fixed injection pulse width and fixed actual fuel delivery amount) under different engine speeds and fuel delivery amount.

Pressure wave in high-pressure pipe

As a pilot injection or a main injection is completed in a common rail fuel injection system, the valve in the

injector is closed very quickly. Then, a so-called water hammer is formed in the injector pipe.¹⁰ Considering the valve in the injector to be open and a flow in the injector pipe, there is an initial pressure P and an initial velocity V in the pipe, as shown in Figure 1. Suddenly after the valve is closed, a pressure wave that travels toward the main rail is created. The fluid between the wave and the valve will be at rest, but the fluid between the wave and the rail will still have the initial velocity V , as shown in Figure 1(b). When the wave reaches the main rail, the whole pipe will have the pressure $P + dP$, although the pressure in the rail will still be P . This imbalance of the pressure makes the fuel flow from the pipe back to the rail with the velocity V and a new pressure wave is created and it travels toward the valve end of the pipe, as shown in Figure 1(c). When the wave reaches the end, the fluid is still flowing. The pressure at this point will be less than the initial value, $P - dP$. This leads to a rarefied wave of the pressure in the other direction (Figure 1(d)). When this wave reaches the rail, the pipe will have a pressure less than that in the rail. There is an imbalance in the pressure again and the process repeats itself in a periodic manner. The result is an oscillation which is damped.

Experimental arrangement

Test engine

The research reported in this article has been undertaken on a 2.2-L four-cylinder four-valve turbocharged DI diesel engine which is typical of passenger car engine with a bore of 86 mm and a stroke 94.6 mm. The turbocharger is VGT type and the VGT actuator is operated pneumatically. The EGR valve also has a pneumatic

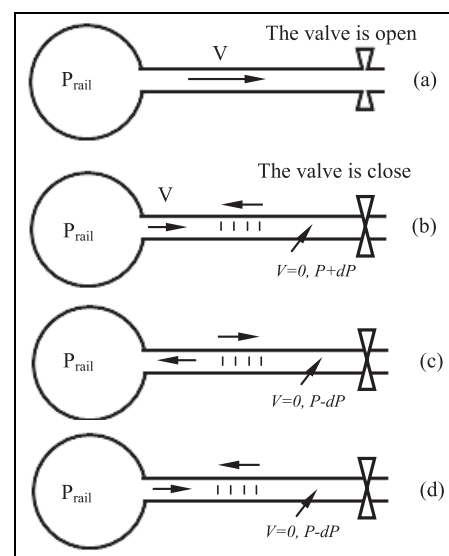

Figure 1. Pressure wave in common rail injection system. P_{rail} - pressure in rail; V - flow velocity; P - pressure in fuel pipe.

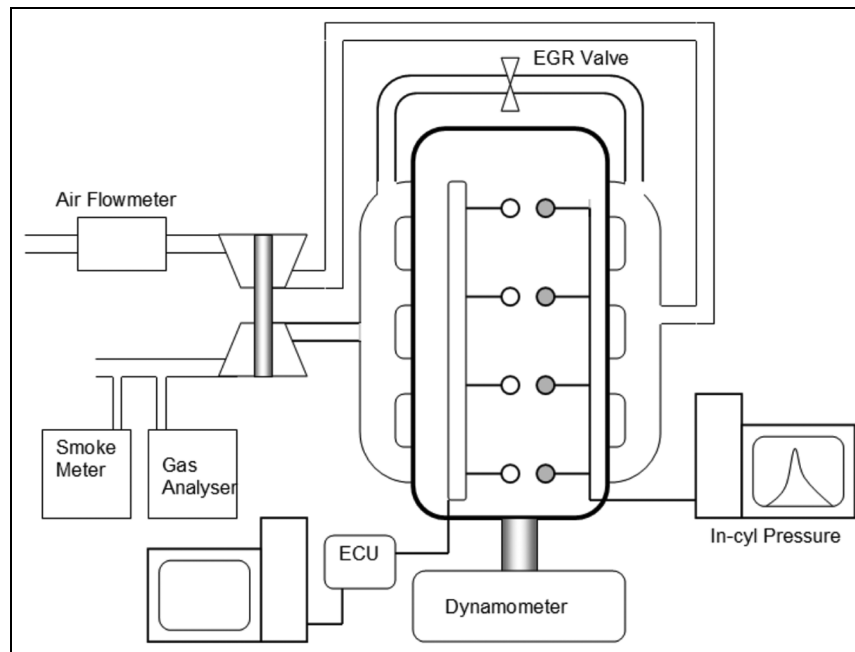

Figure 2. Test engine and measurement equipments.

Table 1. Specification of the experimental engine.

Engine type	2.2-L turbocharged DI diesel engine
Bore	86 mm
Stroke	94.6 mm
Number of cylinder	4
Displacement	2.2 L
Number of valve per cylinder	4
Compression ratio	18
Max. torque	360 N m at 1500 r/min
Max. power	155 kW at 3800 r/min
Turbocharger	VGT with pneumatic actuator
EGR valve	Pneumatic control
Fuel injection system	High-pressure common rail
Max. rail pressure	1600 bar
The orifice diameter of injectors	0.12 mm

DI: direct injection; VGT: variable geometry turbocharger; EGR: exhaust gas recirculation.

actuator. Although the objective of the project is to investigate the effects of the injection system operating parameters on engine performance and emissions, the engine is fitted on a fully instrumented test bed. The schematic of the relevant experimental setup is shown in Figure 2 and the engine specifications are listed in Table 1

The fuel injection system is Delphi HPCR fuel injection which has a 1600-bar maximum fuel injection pressure. The orifice diameter of the nozzles is 0.12 mm and there are six holes in each injector. In Figure 3, the schematic of the injection system is presented.

Measurement equipment

The test bed is fully equipped with various instrumentations which can meet the requirement for a series of engine performance experiments. In addition to the dynamometer, various pressure sensors, and temperature sensors for intake gas, exhaust gas, coolant, lubricant, and so on, a set of Signal[®] gas analyzer is connected with the exhaust pipe for measuring nitrogen oxides (NO_x), CO₂, CO, HC emissions, and oxygen concentration in the exhaust gas.

An AVL smoke meter is also connected with the exhaust pipe for smoke measurement and a Labcell[®] laminar air flow meter is fitted upstream of the air filter (in Figure 2). The air flow meter provides a possibility for estimating intake gas flow rate and also for calculating those emission masses from the parts per million output of the gas analyzer. The in-cylinder pressure is measured with a Kistler-type 6535Q piezoelectric pressure transducer which is fitted through glow plug adaptor. The pressure data are saved and analyzed by a purpose-built data acquisition system based on National Instrument LabVIEW[®] program.

Most fuel injection relevant operating parameters are acquired through the engine control unit (ECU) with a control computer. The computer can control the fuel injection by adjusting those control parameters and also can read out those data for analysis. Those possible parameters include the total fuel amount injected in per cycle, the main fuel injection timing, the pressure in the rail, the pilot injection amount, and the interval between the main injection and pilot injection. It is

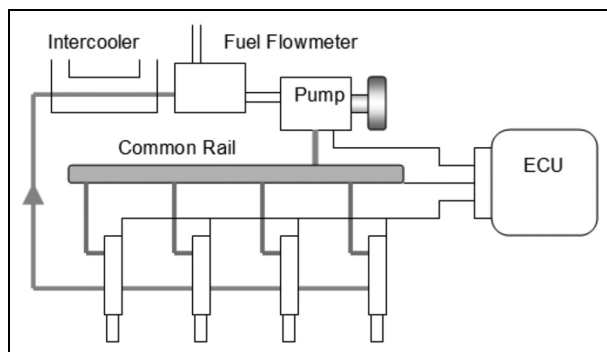

Figure 3. Common rail fuel injection system.

needed to be noted that the actual fuel amount consumed is measured by a fuel flow meter (in Figure 3). The return fuel is cooled and joined into the feeding line after the flow meter. This means the fuel amount measured by the fuel flow meter was actually consumed by the engine.

Measurement process

All measurements presented in this article were carried out under steady-state running conditions. This means when the experiment is moved to a new engine running condition, a certain time must be waited for all the requested parameters to become stable.

Some typical engine running conditions which lie on the New European Driving Cycle were selected for this research. For example, the tests for examining the effects of the main injection timing, the injection pressure, and the pilot injection amount were operated under 1800 r/min and 10 mg total fuel amount (about 30–35 N m torque and 2.0 bar brake mean effective pressure (BMEP)). The experiments for exploring pilot time influence covered a 1000–3000 r/min engine speed and 9–32 mg fuel amount (30–160 N m torque).

When those experiments for investigating the effects of fuel injection on engine performance and emissions were undertaken, VGT and EGR were kept at constant position. For each series test, engine speed and the total fuel amount were also fixed except for the some pilot timing test for which the actual fuel amount is changed by the pressure wave in the rail, although with a fixed injection pulse width.

Results and discussion

The investigations presented in this article are mainly focused on the effects of fuel injection parameters on engine combustion performance and emissions. The results relating injection timings of the main injection and the pilot injection, the injection pressure or

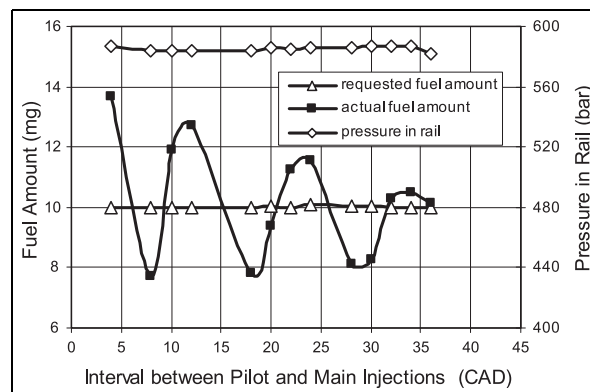

Figure 4. Effects of pilot separation on actual fuel delivery amount with fixed inject pulse width (1500 r/min, 10 mg requested fuel amount).

injection rate, and the pilot injection amount are demonstrated and discussed below.

Pilot separation (interval between pilot and main injections)

The driving motivation behind common rail diesel technology is the adherence to ever-increasing emission regulations while maintaining the drivability and low combustion noise characteristics of petrol-powered engines and the superior fuel economy of the diesel engine. With common rail fuel injection systems, combustion noise can be controlled with a pilot injection of small quantity of fuel prior to main injection, so that the pressure rise during combustion is not steep, resulting in low noise. However, as the interval between the pilot injection and main injection (normally less than 1 ms) is so short, the pressure wave induced by pilot injection or previous injection inevitably causes the subsequent injection difficult to be controlled. Therefore, there is not only the optimal pilot-main interval for noise reduction to be considered for the adjustment and choice of pilot timing but also the effect of the interval on the stabilities of main injection and combustion.

In the following section, the influence of the pilot-main interval on fuel injection is presented and discussed.

For constant requested fuel amount. At first, with fixed engine speed, fixed fuel pressure in the common rail, fixed pilot amount, and fixed pulse width of the total injection control signal (requested fuel amount), the interval between pilot injection and main injection is adjusted to find the variations in fuel injection. In Figure 4, the effect of the interval on the total fuel amount under 1500 r/min engine speed and 10 mg requested fuel amount is shown. Changing the interval

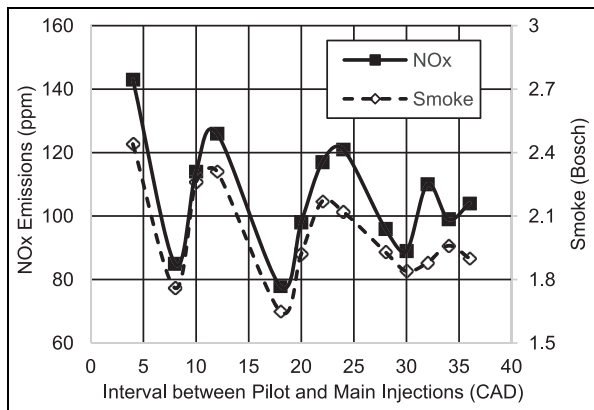

Figure 5. Effects of pilot separation on NOx emissions and smoke with fixed inject pulse width (1500 r/min, 10 mg requested fuel amount).

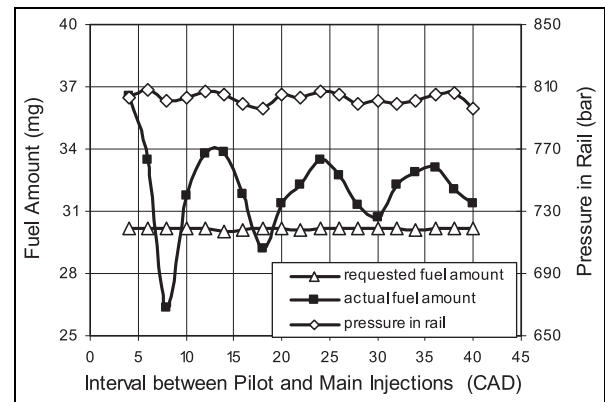

Figure 7. Effects of pilot separation on actual fuel delivery amount with fixed inject pulse width (1500 r/min, 30 mg requested fuel amount).

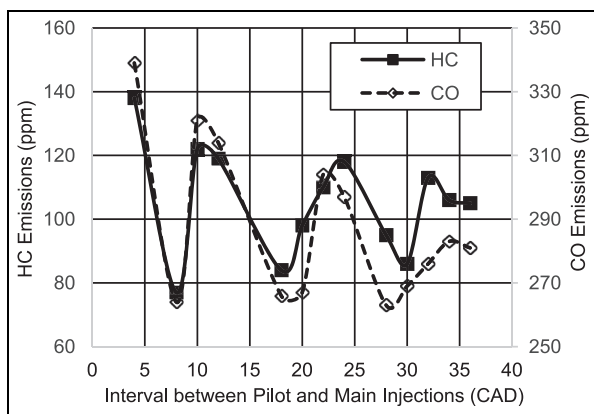

Figure 6. Effects of pilot separation on HC and CO emissions with fixed inject pulse width (1500 r/min, 10 mg requested fuel amount).

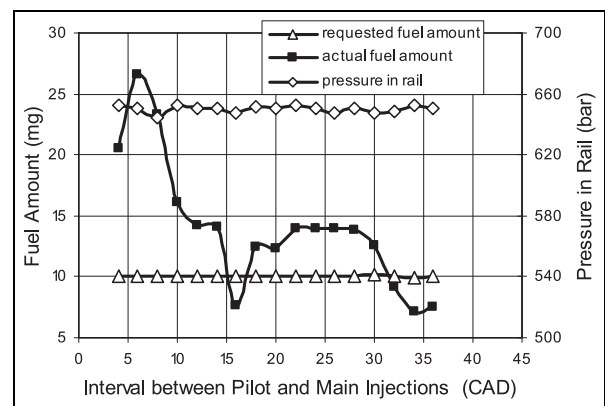

Figure 8. Effects of pilot separation on actual fuel delivery amount with fixed inject pulse width (3000 r/min, 10 mg requested fuel amount).

from 4 to 36 crank angle degree (CAD), the total fuel amount can be changed from 7.5 to 13.5 mg, and this change has a few oscillations from 4 to 36 CAD.

From Figure 4, another characteristic is that short interval has a greater impact on the total fuel amount than long interval. This suggests that more attention should be paid when short interval is selected between two adjacent injections. From Figures 5–7, the results for two different engine speeds and two different pulse widths are displayed. From those results, it suggests that pressure wave induced by previous injection in common rail can always give serious impact to the total fuel amount (or injection rate) and injection stability, although rail pressure and injection pulse width are fixed for each test condition.

As shown in Figure 5 for NOx emissions and smoke, it can be found that NOx emissions and smoke keep

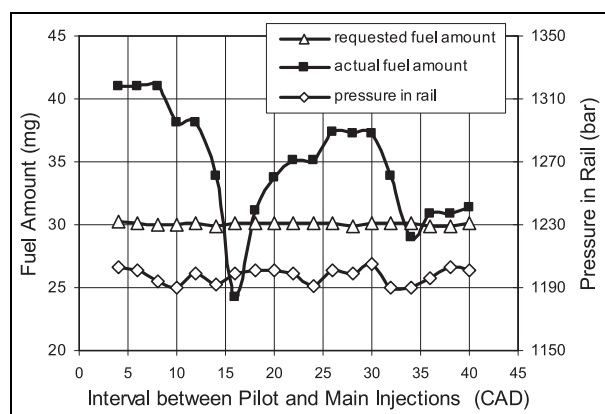

Figure 9. Effects of pilot separation on actual fuel delivery amount with fixed inject pulse width (3000 r/min, 30 mg requested fuel amount).

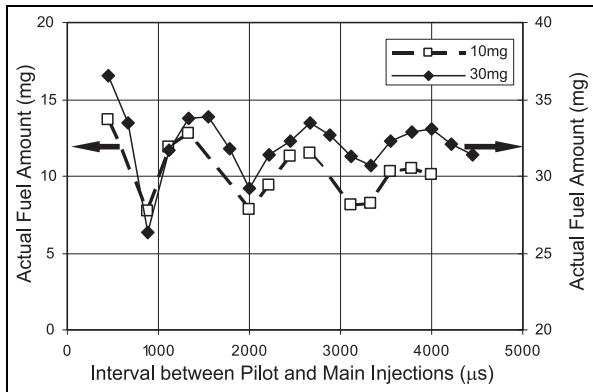

Figure 10. Oscillation of actual fuel amount with the variation in pilot separation under different injection pulse widths with the same engine speed (1500 r/min).

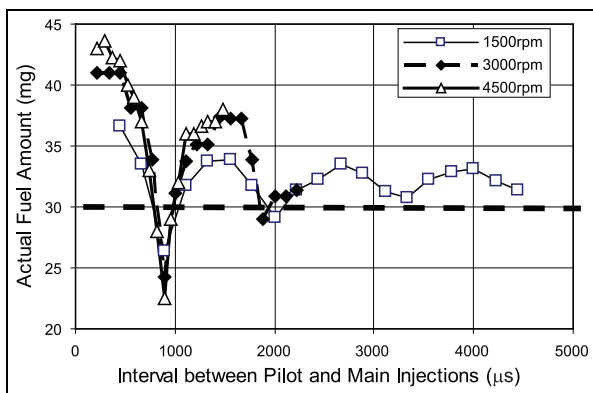

Figure 11. Oscillation of actual fuel amount with the variation in pilot separation under different engine speeds with the same injection pulse width (30 mg requested fuel amount).

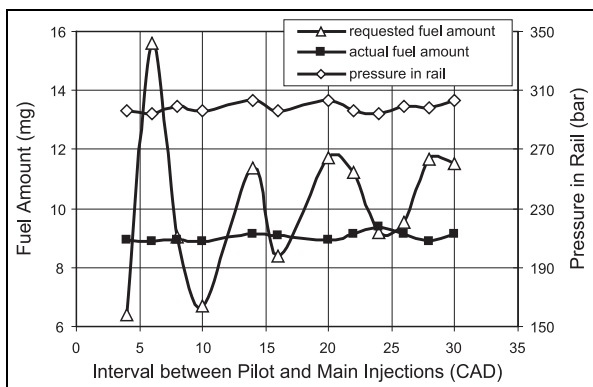

Figure 12. Injection pulse width variation for keeping same fuel delivery amount with different pilot separations (1000 r/min, 9 mg actual fuel amount).

similar fluctuation as the variation in actual quantity. This suggests the influence of pilot separation on NOx emissions and smoke is mainly dominated by the

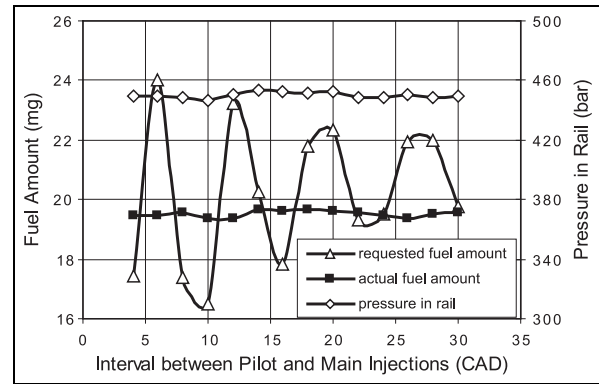

Figure 13. Injection pulse width variation for keeping same fuel delivery amount with different pilot separations (1000 r/min, 19.5 mg actual fuel amount).

variation in actual fuel quantity, although pilot timing should have more or less impact. As shown in Figure 6 for HC and CO emissions, they have similar trends. Owing to this reason, the emission results for other test conditions are not presented.

In Figures 4 and 7–9, it can be seen that the variations in fuel amount with different pilot separations have similar trend for the same engine speed. In Figure 10, those results of the same engine speed but different pulse widths are plotted together for comparing their variation trend. It is noted that for the same engine speed, the oscillation of total fuel delivery amount for different pulse widths has the same frequency relative to time and crank angle (same engine speed).

In Figures 4 and 7–9, for different engine speeds, the oscillation of the total fuel amount with the variation in pilot separation has different frequencies based on crank angle. But if those results are plotted based on time (in Figure 11), it can be seen that there is a same oscillation frequency for different engine speeds. From Figures 10 and 11, it can be concluded that the effect of pilot separation on the total fuel amount (or fuel injection rate) has an inherent frequency, even under different engine speeds and injection control pulse widths.

For constant actual fuel amount. For practical engine operations, under a certain engine speed and power output, the total fuel amount is calibrated for meeting emission and drivability requirements. After the requested fuel amount is fixed, for different pilot timings, the pulse width of the injection control signal should be adjusted so as to meet the requirement of the total fuel amount.

For a fixed actual fuel delivery amount, the variation in the pulse width with pilot separation is shown in Figures 12 and 13 for different engine speeds and actual fuel amount.

In Figures 12 and 13, the results for the same engine speed 1000 r/min but different fuel delivery amounts are

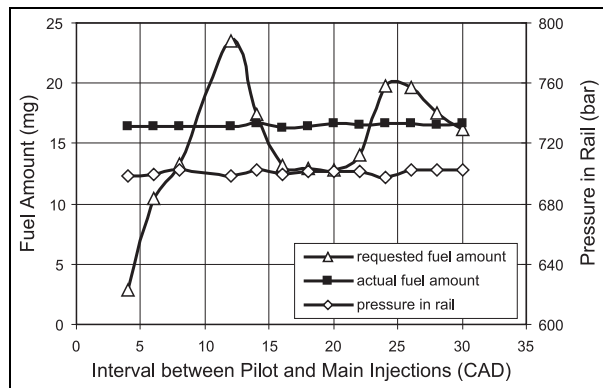

Figure 14. Injection pulse width variation for keeping same fuel delivery amount with different pilot separations (2000 r/min, 16.5 mg actual fuel amount).

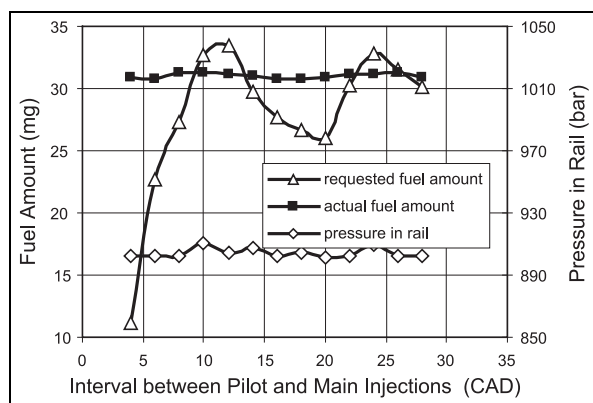

Figure 15. Injection pulse width variation for keeping same fuel delivery amount with different pilot separations (2000 r/min, 31 mg actual fuel amount).

presented. Based on CAD unit of pilot timing, the oscillation frequency of request fuel amount is the same for different actual fuel delivery amounts. Also, the shorter the pilot separation, the stronger the influence of pressure wave on the injection.

In Figures 12–15, it can be seen that with fixed actual fuel amount and rail pressure, the injection pulse width has a variation with the variation in pilot timing. The oscillation has very similar characteristics with the variation in the actual fuel amount shown in the last section when the pulse width is fixed.

In Figure 16, the results for two different injection test methods, fixed injection pulse width and fixed actual fuel delivery amount, are demonstrated. Two results shown in the figure have different engine speeds and different fuel amounts. But the oscillation frequencies of the vibrating parameters are totally the same. This suggests that for a specified common rail fuel injection system, the pressure wave in the common rail has an inherent frequency, regardless of engine speed,

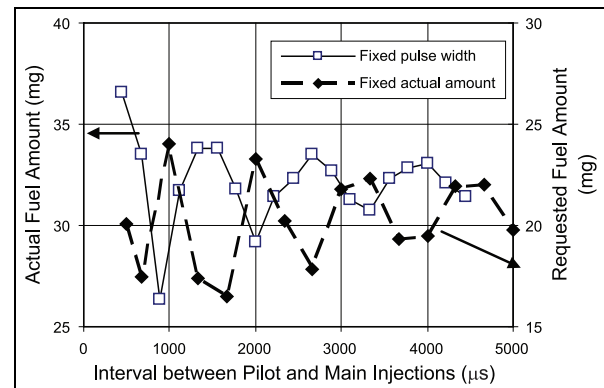

Figure 16. Effects of pressure wave in common rail on fuel injection under different injection test methods (fixed pulse width—1500 r/min, 30 mg requested fuel amount; fixed actual fuel amount—1000 r/min engine speed, 19.5 mg actual fuel amount).

injection pressure, and injection pulse width. Similar results have also been observed on fuel injection test bench by Tian et al.¹¹

Under the effects of pressure wave, there exists a non-linear relationship between electrical separation and hydraulic separation of injection in a common rail system. This requires fuel injection equipment (FIE) manufacturers to use a number of approaches to counter this, including optimizing rail orifices to dampen the wave and using algorithms to predict the error and to adjust for it. In addition, some injectors are especially designed for the injectors to minimize the wave in the high-pressure lines.

Although the above discussion is only for the interval between pilot and main injection, the conclusions can be applied to all possible intervals between two close injections for those multi-pulse injections of common rail injection systems.

Conclusion

The operating characteristics of the common rail fuel injection system of high-speed light-duty diesel engine have been explored on a 2.2-L four-cylinder four-valve turbocharged passenger car DI diesel engine. The subsequent conclusions have been derived from the above results and discussions:

- The effects of pressure wave in the common rail on the main fuel injection were investigated with two different test methods (fixed injection pulse width and fixed actual fuel delivery amount) under different engine speeds and fuel delivery amounts. The results show that the increase or decrease in the pilot separations (intervals between pilot and main injections) causes the

regular oscillation of the actual fuel delivery amount if the injection pulse is fixed or causes the regular oscillation of the injection pulse width if the actual fuel delivery amount is fixed.

- The frequency of regular oscillations of the actual fuel amount or the injection pulse width with the variation in pilot separation is always the same for a specified fuel injection system, regardless of engine speed, fuel amount, injection pulse, and injection pressure.
- As pressure wave causes main injection fuel quantity fluctuation, emissions are mainly affected by the variation in fuel quantity, although pilot injection timing should also have influence on emissions.

Declaration of conflicting interests

The author(s) declared no potential conflicts of interest with respect to the research, authorship, and/or publication of this article.

Funding

The author(s) disclosed receipt of the following financial support for the research, authorship, and/or publication of this article: The financial support from the Royal Academy of Engineering via the Newton Research Collaboration Programme (NRCP/1415/230) is gratefully acknowledged.

References

1. Johnson J, Naber J, Lee S, et al. Correlations of non-vaporizing spray penetration for 3000 bar diesel spray injection. *SAE paper* 2013-24-0033, 2013.
2. Palanisamy M, Lorch J, Truemner R, et al. Combustion characteristics of a 3000 bar diesel fuel system on a single cylinder research engine. *SAE Int J Commer Veh* 2015; 8: 479–490.
3. Giuffrida A, Carlucci P, Ficarella A, et al. Preliminary studies on the effects of injection rate modulation on the combustion noise of a common rail diesel engine. *SAE paper* 2004-01-1848, 2004.
4. Fuyuto T, Taki M, Ueda R, et al. Noise and emissions reduction by second injection in diesel PCCI combustion with split injection. *SAE Int J Engines* 2014; 7: 1900–1910.
5. Dimitriou P, Peng Z, Wang W, et al. Effects of advanced injection strategies on the in-cylinder air–fuel homogeneity of diesel engines. *Proc IMechE, Part D: J Automobile Engineering* 2015; 229: 330–341.
6. Baumann J, Kiencke U, Schlegl T, et al. Practical feasibility of measuring pressure waves in common rail injection systems by magneto-elastic sensors. *SAE paper* 2006-01-0891, 2006.
7. Risi AD, Naccarato F and Laforgia D. Experimental analysis of common rail pressure wave effect on engine emissions. *SAE paper* 2005-01-0373, 2005.
8. Catania AE, Ferrari A and Spessa E. Numerical-experimental study and solutions to reduce the dwell-time threshold for fusion-free consecutive injections in a multi-jet solenoid-type CR system. *J Eng Gas Turb Power* 2009; 131: 022804.
9. Beatrice C, Belardini P, Bertoli C, et al. Combustion process management in common rail DI diesel engines by multiple injection. *SAE paper* 2001-24-0007, 2001.
10. Ubertini S. Injection pressure fluctuations model applied to a multi-dimensional code for diesel engines simulation. *J Eng Gas Turb Power* 2006; 128: 694–701.
11. Tian B, Fan L, Ma X, et al. Investigation of main injection quantity fluctuation due to pilot injection in high pressure common rail fuel injection system. *Int J Smart Sens Intell Syst* 2014; 7: 823–836.